

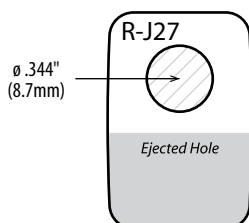

Ejected Hole Hang Tab

EASY TO LOAD ON DISPLAY STRIPS AND PEG HOOKS

Ejected Hole Hang Tabs

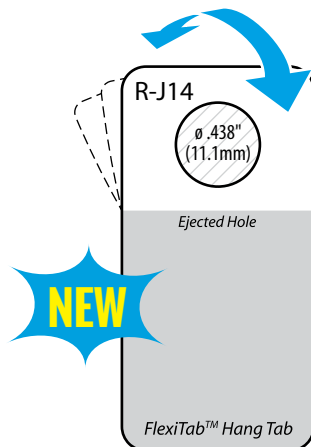
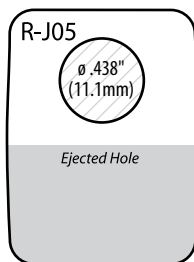

R-J05

	Imperial	Metric
Gauge:	10 mil	254 μ
Dimensions (W x H):	1 x 1.313in	25.4 x 33.3mm
Format:	7M / roll	
Package:	6 x 15.5in roll	15.2 x 39.4cm
Master Carton Quantity:	35M (5 rolls)	
Master Carton Weight:	34lb	15.5kg
Recommended Product Display Weight:	14oz	397g

R-J14

	Imperial	Metric
Gauge:	15 mil	381 μ
Dimensions (W x H):	1 x 2in	25.4 x 50.8mm
Format:	6M / roll	
Package:	6 x 15.5in roll	15.2 x 39.4cm
Master Carton Quantity:	24M (4 rolls)	
Master Carton Weight:	27lb	12.2kg
Recommended Product Display Weight:	9oz	255g

R-J27

	Imperial	Metric
Gauge:	10 mil	254 μ
Dimensions (W x H):	0.75 x 1.125in	19.1 x 28.6mm
Format:	9M / roll	
Package:	6 x 15.5in roll	15.2 x 39.4cm
Master Carton Quantity:	45M (5 rolls)	
Master Carton Weight:	30lb	13.6kg
Recommended Product Display Weight:	10oz	283g

M = 1,000



R-J15

	Imperial	Metric
Gauge:	15 mil	381 μ
Dimensions (W x H):	1.875 x 1.375in	47.6 x 34.9mm
Format:	3M / roll	
Package:	6 x 15.5in roll	15.2 x 39.4cm
Master Carton Quantity:	15M (5 rolls)	
Master Carton Weight:	36lb	16.4kg
Recommended Product Display Weight:	18oz	510g

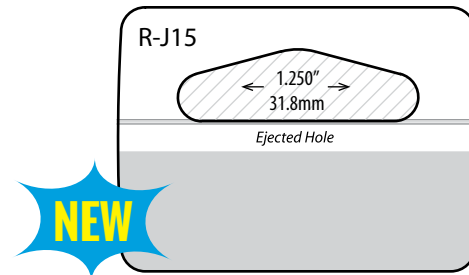

R-J17

	Imperial	Metric
Gauge:	15 mil	381 μ
Dimensions (W x H):	1.875 x 1.375in	47.6 x 34.9mm
Format:	3M / roll	
Package:	6 x 15.5in roll	15.2 x 39.4cm
Master Carton Quantity:	15M (5 rolls)	
Master Carton Weight:	36lb	16.4kg
Recommended Product Display Weight:	18oz	510g

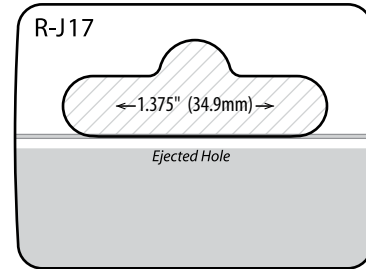

R-J51

	Imperial	Metric
Gauge:	20 mil	508 μ
Dimensions (W x H):	2.5 x 1.5in	64.3 x 38.1mm
Format:	4.5M / roll	
Package:	6 x 15.5in roll	15.2 x 39.4cm
Master Carton Quantity:	13.5M (3 rolls)	
Master Carton Weight:	34lb	15.5kg
Recommended Product Display Weight:	10oz	283g

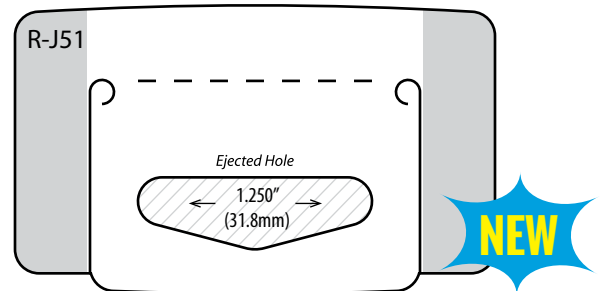

R-JAB

	Imperial	Metric
Gauge:	20 mil	508 μ
Dimensions (W x H):	2.188 x 1.563in	55.6 x 39.7mm
Format:	2M / roll	
Package:	6 x 15.5in roll	15.2 x 39.4cm
Master Carton Quantity:	10M (5 rolls)	
Master Carton Weight:	34lb	15.5kg
Recommended Product Display Weight:	12oz	340g

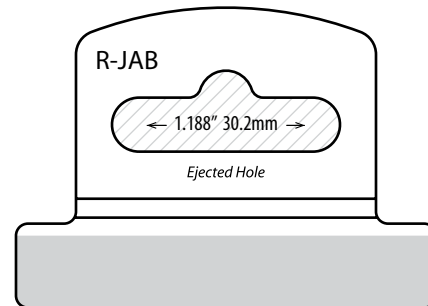

R-JAN

	Imperial	Metric
Gauge:	15 mil	381 μ
Dimensions (W x H):	2 x 2in	50.8 x 50.8mm
Format:	3M / roll	
Package:	6 x 15.5in roll	15.2 x 39.4cm
Master Carton Quantity:	12M (4 rolls)	
Master Carton Weight:	30lb	13.6kg
Recommended Product Display Weight:	12oz	340g

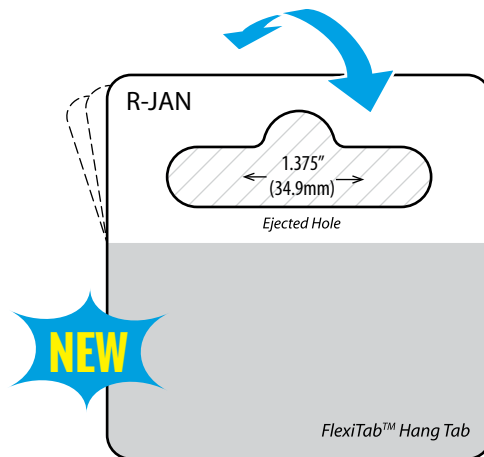

M = 1,000