

# Retail Packaging Seals Security Hang Tabs

from Do-It Corporation



EURO-HOLE SECURITY SEAL  
BOX TOP HANG TAB  
WITH FOLDING PERF



DELTA-HOLE  
FOLDING SECURITY SEAL  
HANG TAB

UCD SECURITY SEAL  
HEAVY GAUGE  
THEFT DETERRENT



UCD SECURITY SEAL  
AVAILABLE AS PRINTED SEAL  
THEFT DETERRENT



- Secure your package.
- Security hang tabs seal your package, hang your product.
- Easy to apply - three application options available.
- Difficult to penetrate - damage the seal, damage the package.
- More durable than wafer seal labels.
- Clear seals let your package graphics show.
- Different thicknesses available.
- Printing and color options available.

# Do-It Security Seals

## DURABLE SEAL TAB

Placed on the corner of your boxed package the R-UCD helps your product stay closed in the store until purchased. The R-UCD is thicker and more difficult to tamper with than thin wafer seals. The R-UCD is available in different thicknesses and clear or printed.

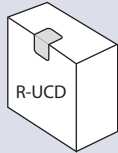

### R-UCD

Gauge:	10 mil (254 $\mu$ )
Dimensions (W x H):	0.6875 x 1.625in (17.5 x 41.3mm)
Format:	9.5M / roll
Package:	6 x 15.5in roll (15.2 x 39.4cm)
Master Carton Quantity:	38M (4 rolls)
Master Carton Weight:	43lb (19.5kg)

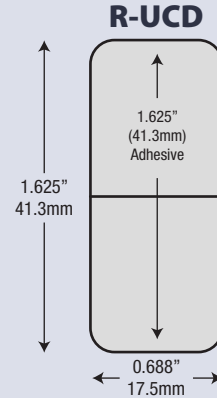

## RESEAL CLOSURE TAB

Use the R-UEH as a resealable closure for your bagged or pouched products. The top, non-adhesive area provides a tab for removing and resealing. Can be provided printed or clear.

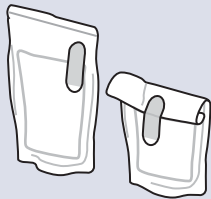

### R-UEH

Gauge:	7 mil (178 $\mu$ ) PP
Dimensions (W x H):	1.0 x 2.5in (25.4 x 63mm)
Format:	7.5M / roll
Package:	6 x 15.5in roll (15.2 x 39.4cm)
Master Carton Quantity:	22.5M (3 rolls)
Master Carton Weight:	50lb (22.7kg)

### R-UEH

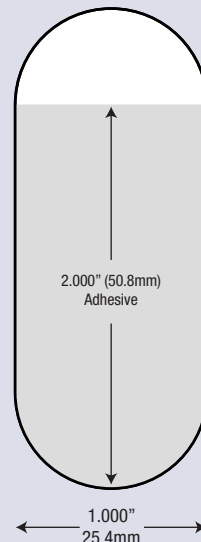

### R-JEH

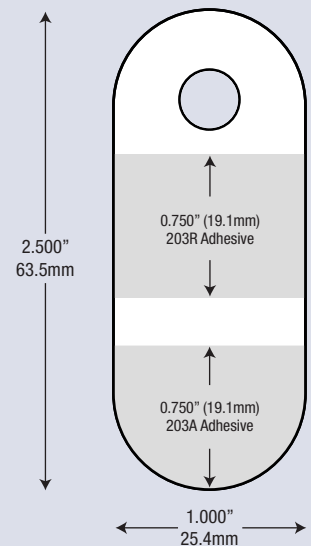

## HANG AND RESEAL TAB

The R-JEH functions as both a hang tab and a removable seal for bag and pouched products. The upper adhesive is removable allowing for opening and sealing the bag. The lower adhesive area is our standard hang tab adhesive, securely holding the hang tab to the package – allowing you to hang your product.

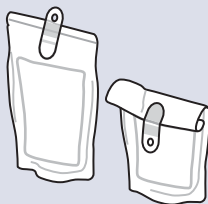

### R-JEH

Gauge:	8 mil (203 $\mu$ ) TPET
Dimensions (W x H):	1.0 x 2.5in (25.4 x 63mm)
Format:	7.5M / roll
Package:	6 x 15.5in roll (15.2 x 39.4cm)
Master Carton Quantity:	22.5M (3 rolls)
Master Carton Weight:	50lb (22.7kg)

## SEAL-TEAR TAB

The R-UEJ folds over the edge of any box, providing a durable seal. Use the pull tab to quickly and easily open/break the seal.

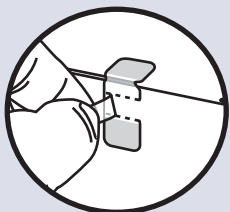

### R-UEJ

Gauge:	8 mil (203 $\mu$ ) TPET
Dimensions (W x H):	0.625 x 1.75in (15.9 x 44.5mm)
Format:	8.25M / roll
Package:	6 x 15.5in roll (15.2 x 39.4cm)
Master Carton Quantity:	33M (4 rolls)
Master Carton Weight:	45lb (20.4kg)

### R-UEJ

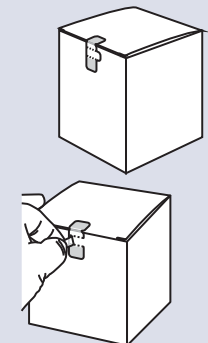
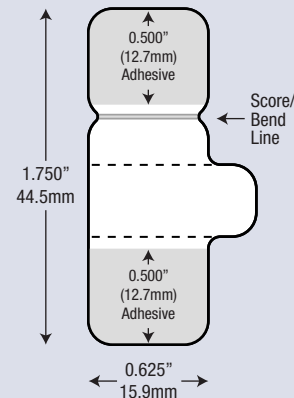

Do-It Corporation |  
 PO Box 592 | 1201 Blue Star Highway |  
 South Haven, Michigan 49090-0592 | USA |  
 (800) 426-4822 | (269) 637-1121 | Fax (269) 637-7223 | [www.do-it.com](http://www.do-it.com) |



# Do-It Security Hang Tabs

Seal your box, hang your product.

## C-HBK

Gauge:	20 mil (508 μ)
Dimensions (W x H):	1.75 x 2.313in 44.5 x 58.7mm
Format:	7.5M / economy roll
Package:	6 x 15.5in roll (15.2 x 39.4cm)
Master Carton Quantity:	7.5M (1 roll)
Master Carton Weight:	30lb (13.6kg)
Recommended Product	10oz (283g)
Display Weight:	

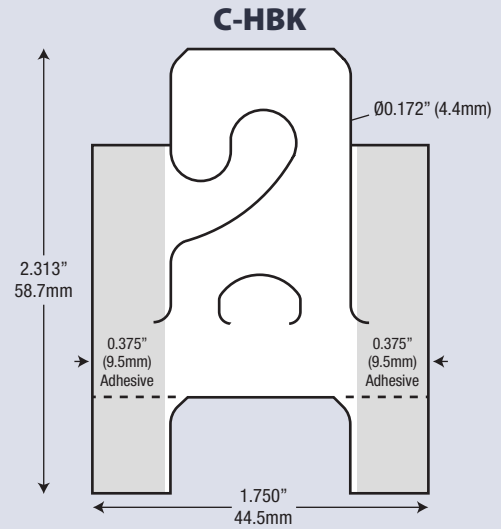
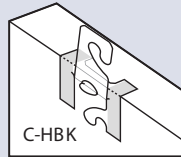

## R-KEP

Gauge:	20 mil (508 μ)
Dimensions (W x H):	2.594 x 2.313in (65.9 x 58.7mm)
Format:	1.5M / roll
Package:	6 x 15.5in roll (15.2 x 39.4cm)
Master Carton Quantity:	3M (2 rolls)
Master Carton Weight:	23lb (10.4kg)
Recommended Product	20oz (567g)
Display Weight:	

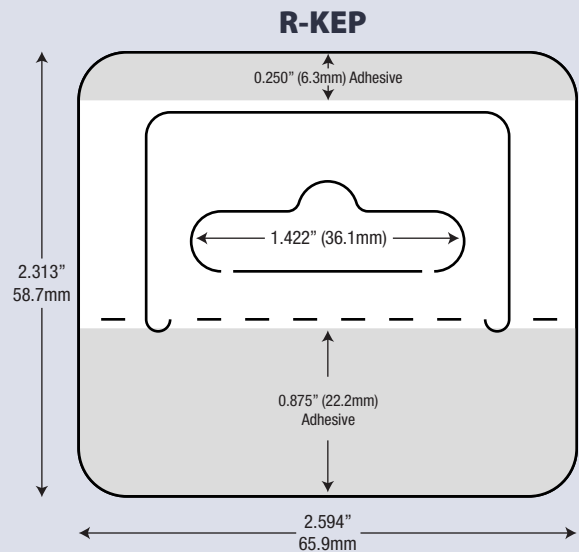
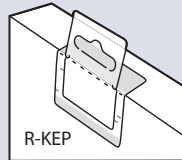

## C-KFF

Gauge:	15 mil (381 μ)
Dimensions (W x H):	3 x 2.25in 76.2 x 44.5mm
Format:	10M / economy roll
Package:	6 x 15.5in roll (15.2 x 39.4cm)
Master Carton Quantity:	10M (1 roll)
Master Carton Weight:	50lb (22.8kg)
Recommended Product	20oz (567g)
Display Weight:	

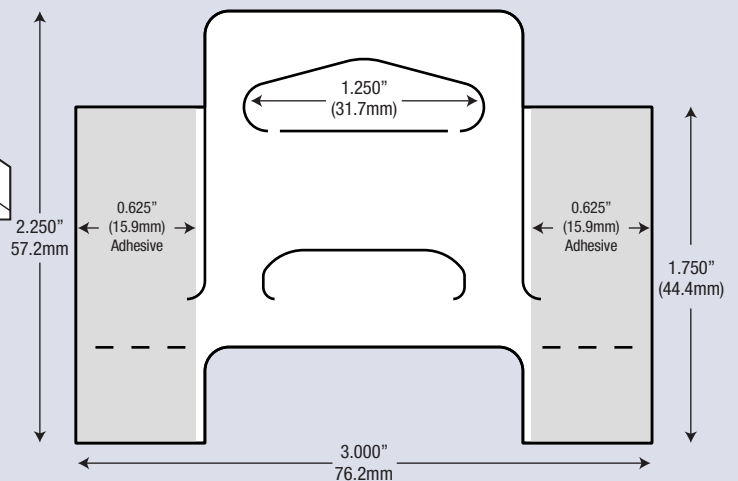
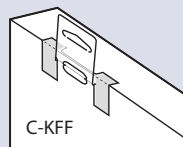

Do-It Corporation |  
 PO Box 592 | 1201 Blue Star Highway |  
 South Haven, Michigan 49090-0592 | USA |  
 (800) 426-4822 | (269) 637-1121 | Fax (269) 637-7223 | [www.do-it.com](http://www.do-it.com) |

# Ideas to Hang, Promote, and Sell Your Product

from Do-It Corporation



Call 1-800-426-4822 or 269-637-1121  
for a detailed product guide or help with  
specific product display questions.

## Application Options



- Hand Application
- Semi-Automatic Application
- Automatic Application



Do-It Corporation |  
PO Box 592 | 1201 Blue Star Highway |  
South Haven, Michigan 49090-0592 | USA |  
(800) 426-4822 | (269) 637-1121 | Fax (269) 637-7223 | [www.do-it.com](http://www.do-it.com) |