

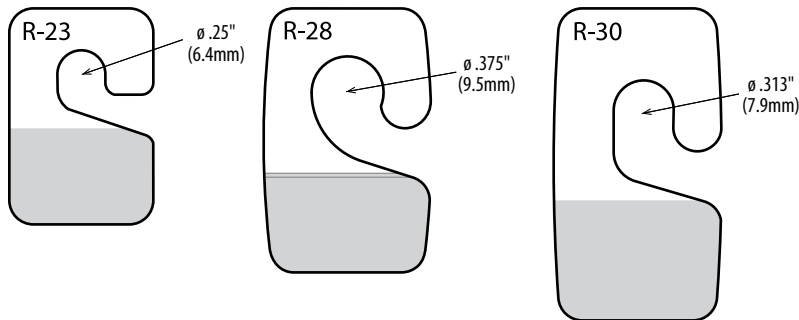

# Hook Hang

ALLOW BACKSHOPPING  
EASILY REMOVE AND REPLACE PRODUCT

## Hook Hang Tabs



### R-23

	Imperial	Metric
Gauge:	10 mil	254 $\mu$
Dimensions (W x H):	0.75 x 1.125in	19.1 x 28.6mm
Format:	6M / roll	
Package:	3 x 12in roll	7.6 x 30.5cm
Master Carton Quantity:	48M (8 rolls)	
Master Carton Weight:	30lb	13.6kg
Recommended Product Display Weight:	3oz	85g

### R-28

	Imperial	Metric
Gauge:	15 mil	381 $\mu$
Dimensions (W x H):	0.875 x 1.375in	22.2 x 34.9mm
Format:	6M / roll	
Package:	6 x 15.5in roll	15.2 x 39.4cm
Master Carton Quantity:	30M (5 rolls)	
Master Carton Weight:	31lb	14.1kg
Recommended Product Display Weight:	6oz	170g

### R-30

	Imperial	Metric
Gauge:	20 mil	508 $\mu$
Dimensions (W x H):	0.873 x 1.625in	22.2 x 41.3mm
Format:	5M / roll	
Package:	6 x 15.5in roll	15.2 x 39.4cm
Master Carton Quantity:	20M (4 rolls)	
Master Carton Weight:	32lb	14.5kg
Recommended Product Display Weight:	12oz	340g

M = 1,000

# Tabs



## Hook Hang Tabs

R-33	Imperial	Metric
Gauge:	25 mil	635 $\mu$
Dimensions (W x H):	1.106 x 1.75in	28.1 x 44.5mm
Format:	3.5M / roll	
Package:	6 x 15.5in roll	15.2 x 39.4cm
Master Carton Quantity:	14M (4 rolls)	
Master Carton Weight:	36lb	16.4kg
Recommended Product Display Weight:	14oz	397g

R-35	Imperial	Metric
Gauge:	25 mil	635 $\mu$
Dimensions (W x H):	1.813 x 2.125in	46 x 54mm
Format:	2M / roll	
Package:	6 x 15.5in roll	15.2 x 39.4cm
Master Carton Quantity:	6M (3 rolls)	
Master Carton Weight:	33lb	15kg
Recommended Product Display Weight:	20oz	567g

M = 1,000

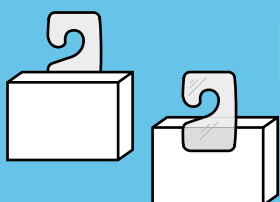
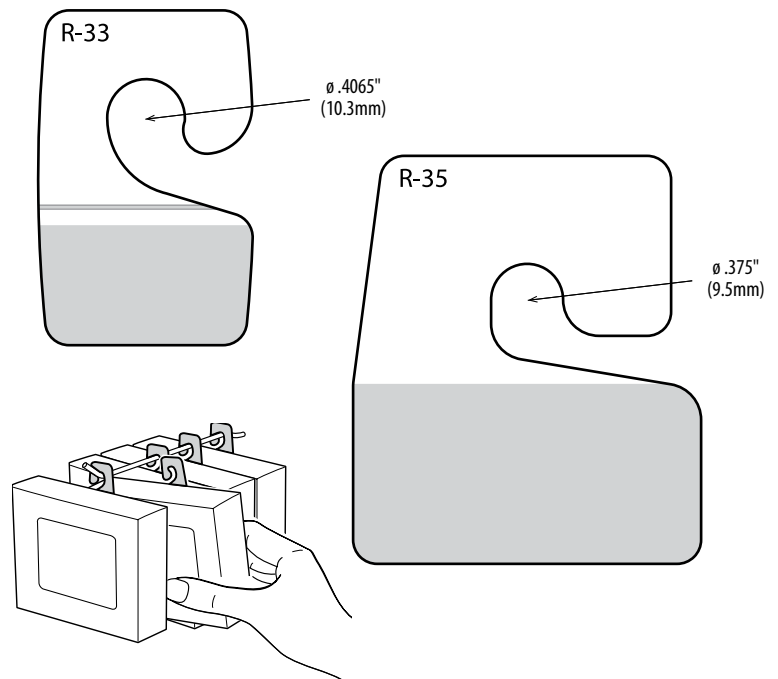

## RIGHT HAND ... OR ... LEFT HAND?

Hook hang tabs can be “right hand” or “left hand” peg hook removal – depending on the design and placement (front or backside).

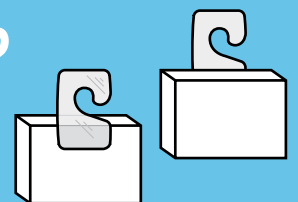

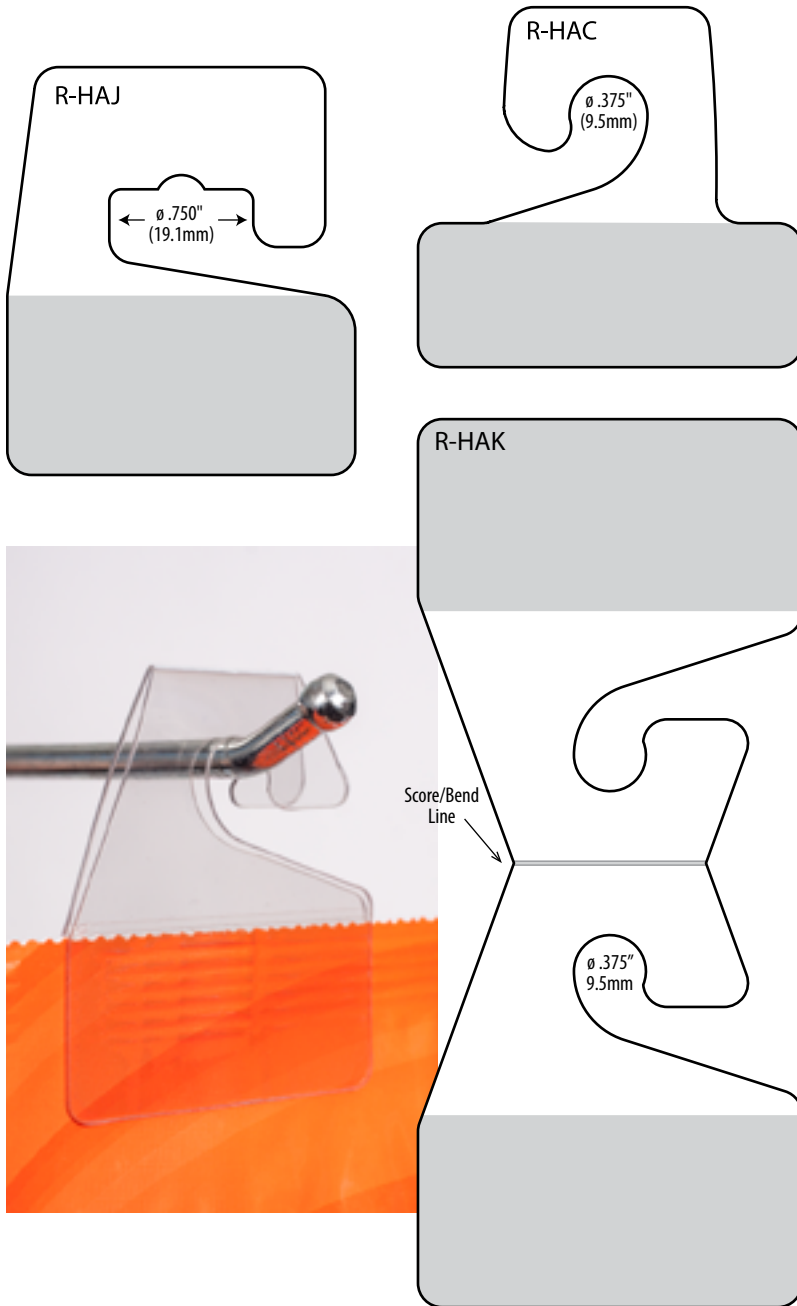

## R-HAC

	Imperial	Metric
Gauge:	20 mil	508 μ
Dimensions (W x H):	1.984 x 1.875in	50.4 x 47.6mm
Format:	2.5M / roll	
Package:	6 x 15.5in roll	15.2 x 39.4cm
Master Carton Quantity:	7.5M (3 rolls)	
Master Carton Weight:	27lb	12.3kg
Recommended Product Display Weight:	12oz	340g

## R-HAJ

	Imperial	Metric
Gauge:	25 mil	635 μ
Dimensions (W x H):	1.813 x 2.125in	46 x 54mm
Format:	2M / roll	
Package:	6 x 15.5in roll	15.2 x 39.4cm
Master Carton Quantity:	6M (3 rolls)	
Master Carton Weight:	31lb	14.1kg
Recommended Product Display Weight:	16oz	454g

## R-HAK

	Imperial	Metric
Gauge:	20 mil	508 μ
Dimensions (W x H):	2 x 4.625in	50.8 x 117.5mm
Format:	2M / roll	
Package:	6 x 15.5in roll	15.2 x 39.4cm
Master Carton Quantity:	4M (2 rolls)	
Master Carton Weight:	38lb	17.3kg
Recommended Product Display Weight:	40oz	1,132g

M = 1,000

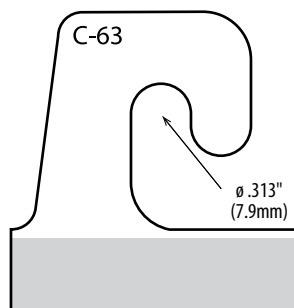

## C-63

	Imperial	Metric
Gauge:	20 mil	508 μ
Dimensions (W x H):	1.5 x 1.563in	38.1 x 39.7mm
Format:	20 / sheet	
Package:	5M box	
Master Carton Quantity:	25M (5 boxes)	
Master Carton Weight:	44lb	20kg
Recommended Product Display Weight:	12oz	340g

M = 1,000

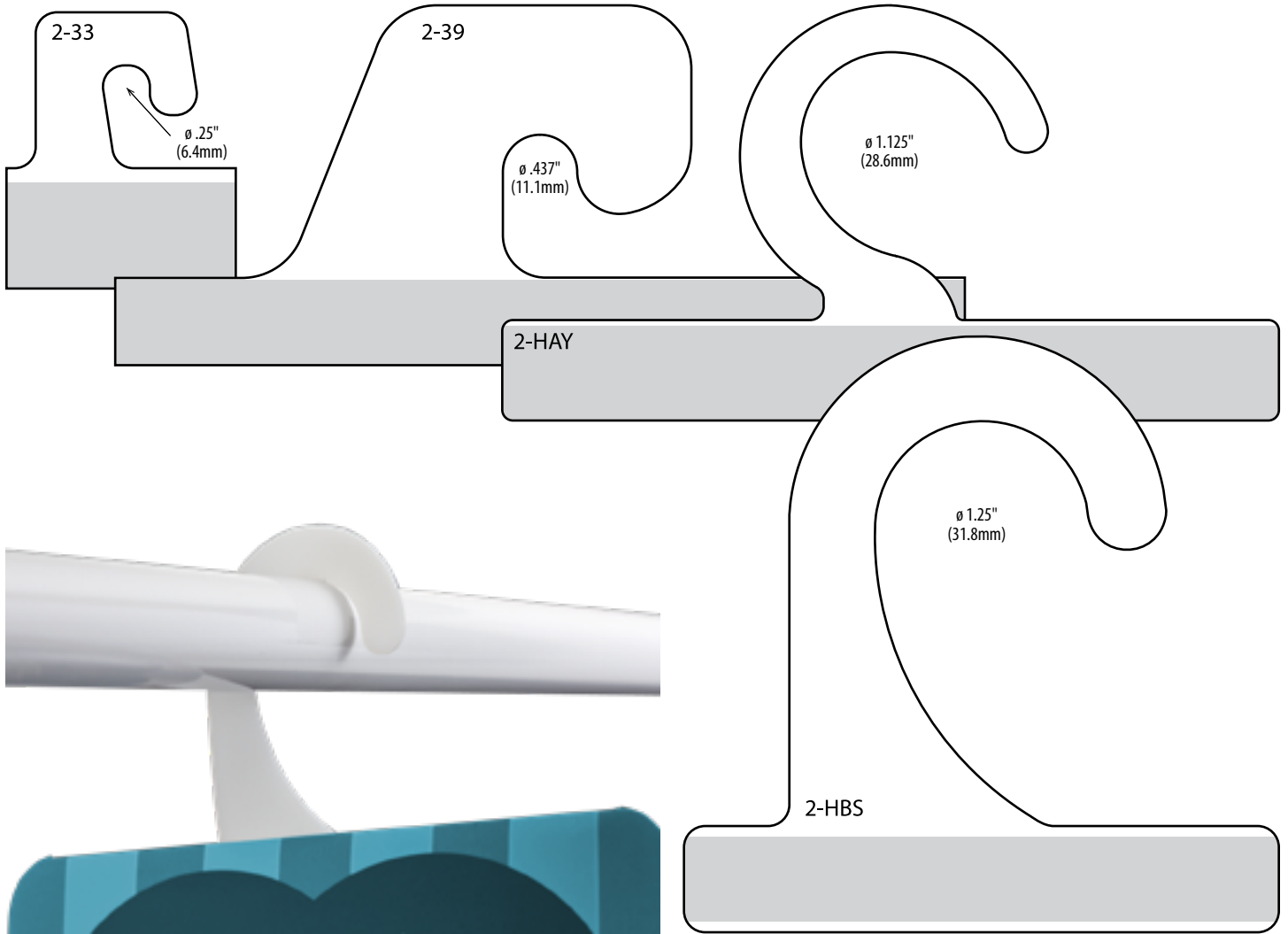

## 2-33

	Imperial	Metric
Gauge:	25 mil	635 $\mu$
Dimensions (W x H):	1.345 x 1.625in	34.3 x 41.3mm
Format:	loose piece	
Package:	500 bag	
Master Carton Quantity:	5M (10 bags)	
Master Carton Weight:	12lb	5.5kg
Recommended Product Display Weight:	18oz	510g

## 2-39

	Imperial	Metric
Gauge:	50 mil	1270 $\mu$
Dimensions (W x H):	5 x 2.125in	127 x 54mm
Format:	loose piece	
Package:	1M carton	
Master Carton Quantity:	1M (1 carton)	
Master Carton Weight:	20 lb	9.1kg
Recommended Product Display Weight:	24oz	680g

M = 1,000

## 2-HAY

	Imperial	Metric
Gauge:	50 mil	1270 $\mu$
Dimensions (W x H):	4.57 x 2.442in	116.1 x 62.1mm
Format:	loose piece	
Package:	2.5M box	
Master Carton Quantity:	2.5M (1 carton)	
Master Carton Weight:	30lb	13.6kg
Recommended Product Display Weight:	10oz	283g

## 2-HBS

	Imperial	Metric
Gauge:	50 mil	1270 $\mu$
Dimensions (W x H):	3.5 x 3.5in	88.9 x 88.9mm
Format:	loose piece	
Package:	2.5M box	
Master Carton Quantity:	2.5M (1 carton)	
Master Carton Weight:	25lb	11.4kg
Recommended Product Display Weight:	10oz	283g

M = 1,000

# Hook Fold-Up

LIE FLAT FOR SHIPPING  
FOLD UP FOR HANGING

## Hook Fold-Up Hang Tabs

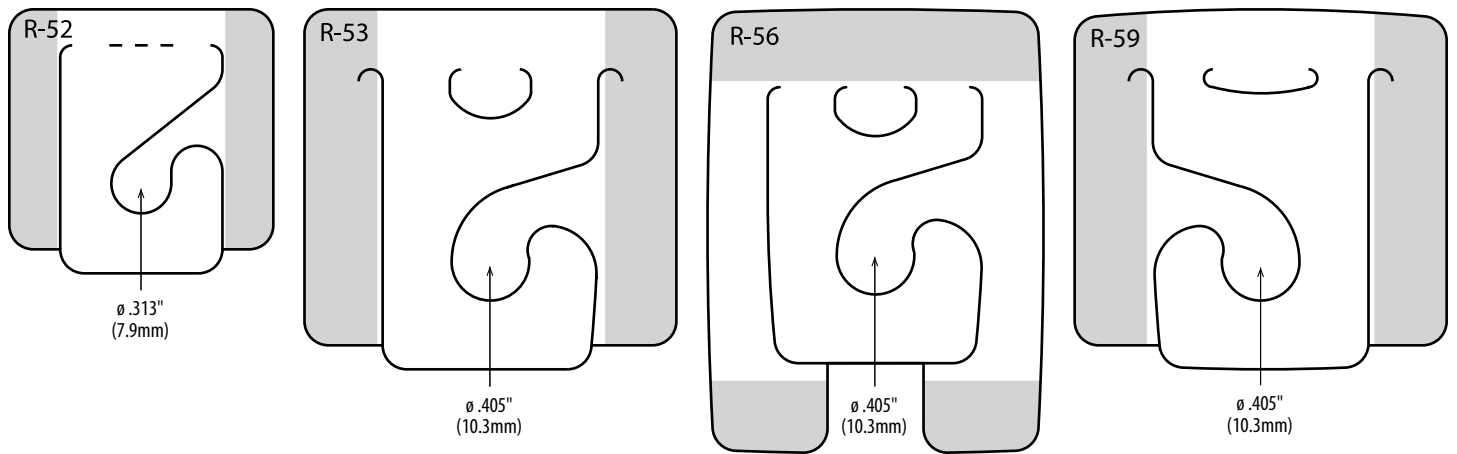

### R-52

	Imperial	Metric
Gauge:	15 mil	381 $\mu$
Dimensions (W x H):	1.375 x 1.375in	34.9 x 34.9mm
Format:	4M / roll	
Package:	6 x 15.5in roll	15.2 x 39.4cm
Master Carton Quantity:	20M (5 rolls)	
Master Carton Weight:	37lb	16.8kg
Recommended Product Display Weight:	6oz	170g

### R-53

	Imperial	Metric
Gauge:	20 mil	508 $\mu$
Dimensions (W x H):	1.938 x 1.875in	49.2 x 47.6mm
Format:	2.5M / roll	
Package:	6 x 15.5in roll	15.2 x 39.4cm
Master Carton Quantity:	7.5M (3 rolls)	
Master Carton Weight:	34lb	15.5kg
Recommended Product Display Weight:	11oz	311g

### R-56

	Imperial	Metric
Gauge:	20 mil	508 $\mu$
Dimensions (W x H):	1.75 x 2.312in	44.5 x 58.1mm
Format:	2.5M / roll	
Package:	6 x 15.5in roll	15.2 x 39.4cm
Master Carton Quantity:	7.5M (3 rolls)	
Master Carton Weight:	36lb	16.3kg
Recommended Product Display Weight:	11oz	311g

### R-59

	Imperial	Metric
Gauge:	20 mil	508 $\mu$
Dimensions (W x H):	1.938 x 1.875in	49.2 x 47.6mm
Format:	2M / roll	
Package:	6 x 15.5in roll	15.2 x 39.4cm
Master Carton Quantity:	8M (4 rolls)	
Master Carton Weight:	37lb	16.8kg
Recommended Product Display Weight:	11oz	311g

M = 1,000

# Hang Tabs



## Hook Fold-Up Hang Tabs

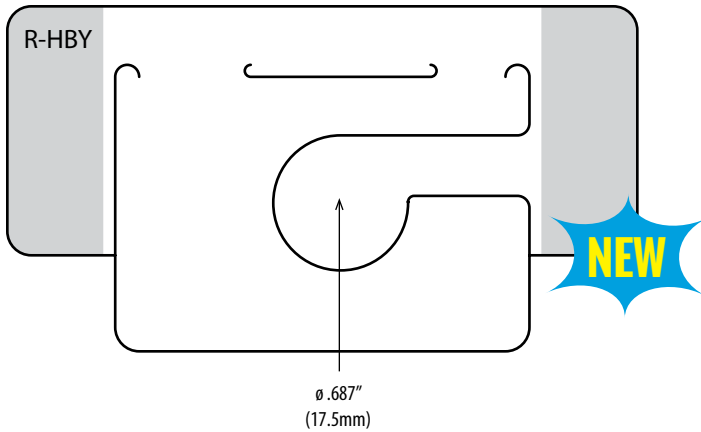

### R-HBY

	Imperial	Metric
Gauge:	25 mil	635 $\mu$
Dimensions (W x H):	3.281 x 1.797in	83.3 x 45.6mm
Format:	2M / roll	
Package:	6 x 15.5in roll	15.2 x 39.4cm
Master Carton Quantity:	4M (2 rolls)	
Master Carton Weight:	32lb	14.5kg
Recommended Product Display Weight:	14oz	397g

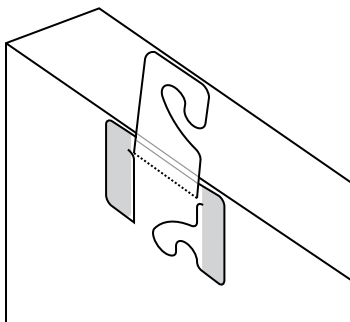

### Economy Roll

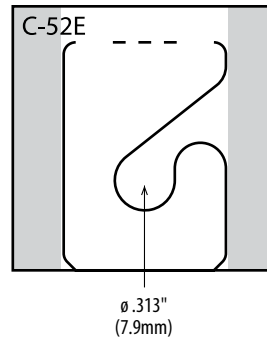

### C-52E

	Imperial	Metric
Gauge:	15 mil	381 $\mu$
Dimensions (W x H):	1.375 x 1.375in	34.9 x 34.9mm
Format:	20M / economy roll	
Package:	6 x 15.5in roll	15.2 x 39.4cm
Master Carton Quantity:	20M (1 roll)	
Master Carton Weight:	37lb	16.8kg
Recommended Product Display Weight:	6oz	170g

### Economy Roll

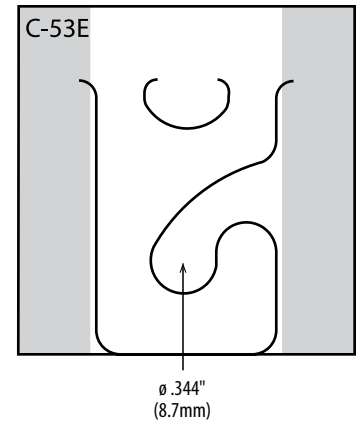

### C-53E

	Imperial	Metric
Gauge:	20 mil	508 $\mu$
Dimensions (W x H):	1.75 x 1.813in	44.5 x 46mm
Format:	8M / economy roll	
Package:	6 x 15.5in roll	15.2 x 39.4cm
Master Carton Quantity:	8M (1 roll)	
Master Carton Weight:	33lb	15kg
Recommended Product Display Weight:	11oz	311g

M = 1,000